

# LT-840-350 4CH CC DMX512 DECODER



LT-840-350 is a 4CH CC DMX512 decoder, output 350mA CC PWM signal per channel, controls hi-power LED lamps without CC driving IC (e.g.: LED downlights) or with the current-limiting resistor (e.g.: LED strips) and the low power LED lamps (e.g.: LED panel lights). The DMX decoder works with DMX512 console, 256 grayscale output per channel, 0-100% dimming range with various changing effects. Equipped with DMX standard XLR-3, RJ45 and green terminal interface, control single color, bi-color, RGB and RGBW/Y LED lights.

## 1. Product Parameter:

### LT-840-350

- Input Voltage: 12~48VDC
- Output Voltage: 3~42VDC
- Output Current: CC 350mA×4CH
- Output Power: 1.05W~14.7W×4CH Max 58.8W
- Driving LEDs: Series 1~12pcs 1W LEDs×4CH
- DMX512 Socket: XLR-3, RJ45, Green Terminal
- Input Signal: DMX512
- Dimming Range: 0~100%
- Working Temperature: -30°C~65°C
- Dimensions: L156×W78×H40(mm)
- Package Size: L180×W82×H48(mm)
- Weight (G.W.): 445g

## 2. Product Size:

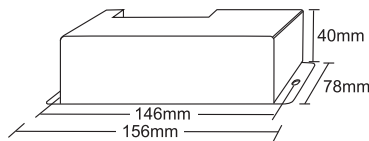

## 3. Configuration Diagram:

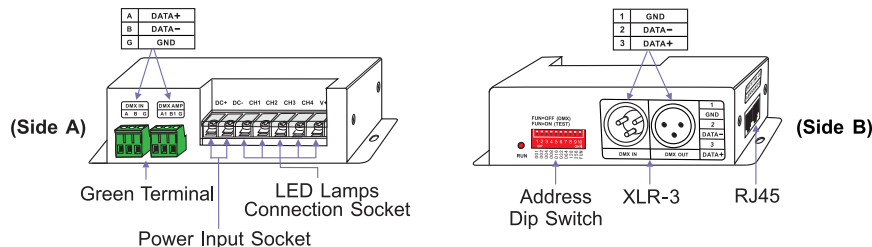

1

2

## 4. Dip Switch Operation:

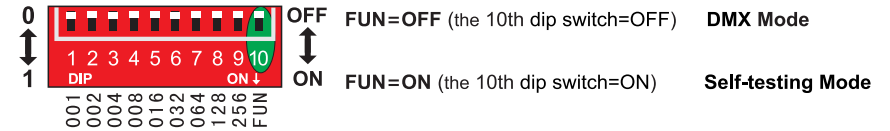

### 4.1 DMX Mode:

**FUN=OFF** (the 10th dip switch=OFF) **DMX Mode**

DMX address value=the total value of (1-9), to get the place value when in “on” position, otherwise will be 0.

E.g.1: Set Initial Address To 32. E.g.2: Set Initial Address To 37. E.g.3: Set Initial Address To 178.

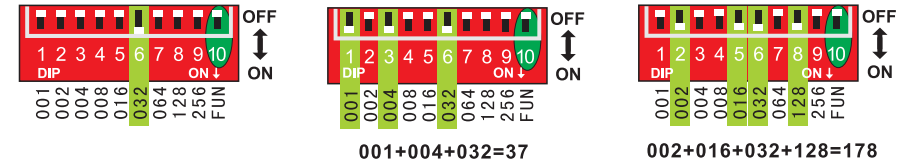

\* When Dip switch 1-9 are OFF, the defaulted initial DMX address is 1.

### 4.2 DMX Dimming Instruction:

Each LT-840-350 DMX decoder occupied 4 DMX addresses when connecting the DMX console, e.g., the defaulted initial DMX address is 1, please find their corresponding relationships in the following form:

DMX Console Channel	DMX Decoder Output Channel
CH1 0-255	CH1 PWM 0-100% (LED R)
CH2 0-255	CH2 PWM 0-100% (LED G)
CH3 0-255	CH3 PWM 0-100% (LED B)
CH4 0-255	CH4 PWM 0-100% (LED W/Y)

### 4.3 Manual Dimming Functions:

As figure, while FUN=OFF, disconnect the DMX512 signal, entering the manual dimming mode with the dip switch.

Brightness	DIP1-3(CH1)	DIP4-6(CH2)	DIP7-9(CH3)	Figure
0	000	000	000	
14%	100	100	100	
28%	010	010	010	
43%	110	110	110	
57%	001	001	001	
71%	101	101	101	
86%	011	011	011	
100%	111	111	111	

4.4 Self-testing Mode:

FUN=ON (the 10th dip switch=ON) Self-testing Mode

Dip Switch	1-9=off	1=on	2=on	3=on	4=on	5=on	6=on	7=on	8=on	9=on
Self-test Function	Static Black	Static Red	Static Green	Static Blue	Static Yellow	Static Purple	Static Cyan	White Strobe	7 Colors Jumping	7 Colors Smooth



Static Red    Static Blue    Static Purple    White Strobe    7 Colors Smooth  
 Static Green    Static Yellow    Static Cyan    7 Colors Jumping

OFF  
 ON

For changing effects (Dip Switch 8/9=on):  
 DIP switch 1-6 is used to realize 6 speed levels. (6=on, the fastest level)

For changing effect (Dip Switch 7=on):  
 Static white will be showed when 1=on or 6=on. 2-5=on will be white strobe effect.

[Attn] When several dip switches are on, subjected to the highest switch value.  
 As the figure above shows, the effect will be 7 colors smooth at 6 speed level.

5. Wiring Diagram:

5.1 Decoder can be connected to a variety of standard DMX512 devices:

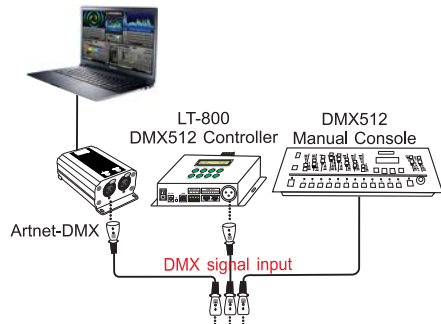

- LT-840-350 works with any brand DMX console. Check the following wiring diagram when connecting to Artnet-DMX, our LT-800 DMX controller and the DMX manual console.
- LT-840-350 is equipped with 3 types DMX terminals for users' selection. The following diagram takes XLR-3 as an example, same connecting method for the rest two: green terminal(with amplifier function) & RJ45.
- The LED quantity at each channel can be different; LT-840-350 could auto check and output a proper voltage to each channel according to its LED quantities.
- LT-840-350 works on the technique of voltage reduction, the voltage of power supply should be no less than the total voltage of the connected lamps.

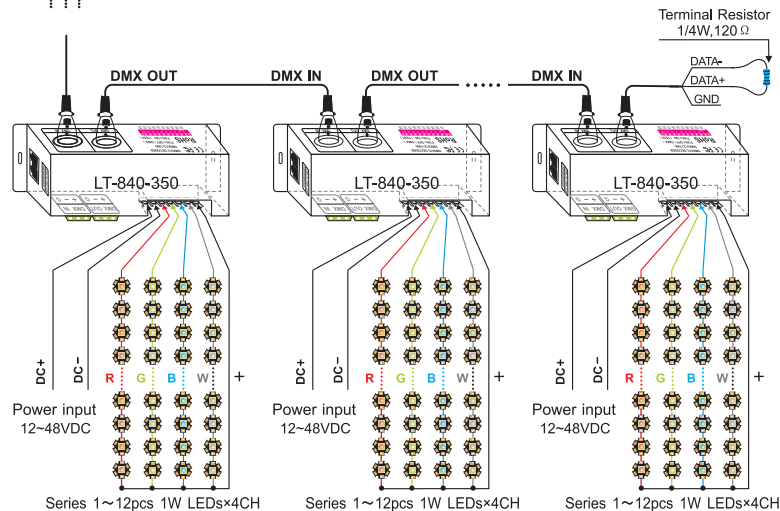

5.2 The connection diagram of three DMX terminals:

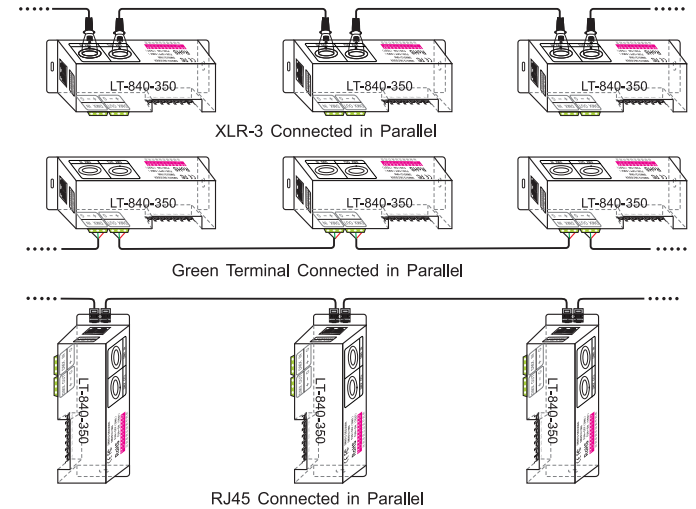

These 3 terminals can be connected in a mixed way.

6. Attention:

- The product shall be installed and serviced by the qualified person.
- This product is non-waterproof. Please avoid the sun and rain. When installed outdoors please ensure it is mounted in a water proof enclosure.
- Good heat dissipation will prolong the working life of the controller. Please ensure good ventilation.
- Please check if the output voltage of the LED power supply used comply with the working voltage of the product.
- Please ensure that adequate sized cable is used from the controller to the LED lights to carry the current. Please also ensure that the cable is secured tightly in the connector.
- Ensure all wire connections and polarities are correct before applying power to avoid any damages to the LED lights.
- If a fault occurs, please return the product to your supplier. Do not attempt to fix this product by yourself.

7. Warranty Agreement:

- We provide lifelong technical assistance with this product:
    - A 5-year warranty is given from the date of purchase. The warranty is for free repair or replacement if cover manufacturing faults only.
    - For faults beyond the 5-year warranty, we reserve the right to charge for time and parts.
  - Warranty exclusions below:
    - Any man-made damages caused from improper operation, or connecting to excess voltage and overloading.
    - The product appears to have excessive physical damage.
    - Damage due to natural disasters and force majeure.
    - Warranty label, fragile label and unique barcode label have been damaged.
    - The product has been replaced by a brand new product.
  - Repair or replacement as provided under this warranty is the exclusive remedy to the customer. LTECH shall not be liable for any incidental or consequential damages for breach of any stipulation in this warranty.
  - Any amendment or adjustment to this warranty must be approved in writing by LTECH only.
- ★ This manual only applies to this model. LTECH reserve the right to make changes without prior notice.